

Features

- Low Cost
- 3125ppm Divider Ratio (2.500V at 800V)
- 0.75% Accuracy (23ppm)
- +/-2ppm Temperature Stability
- +/-2ppm Gain Linearity over voltage
- Voltage Sensing up to +/-1200V
- Very small TSSOP8 4.4mm package (1400V rating)
- Rail-to-Rail output
- 1kHz Low-Pass HV Filtering
- Voltage Buffer with $<|2mV|$ Offset Voltage

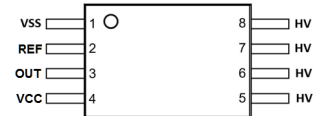

TSSOP-8 Wide-body (4.4mm)

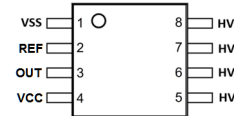

DUAL in LINE 8 pin

Applications

- Automotive EV Powertrain and Inverters
- Cardiac Defibrillators
- Industrial High Voltage Sensing

Description

The 18SCT005 is a very accurate ($\pm 0.75\%$) voltage divider typically used to sense system voltage from $\pm 150V$ to $\pm 1200V$. The nominal gain of 3125ppm is extremely constant with temperature and voltage varying by about 4ppm from -40 to $105C$ at $800V$. For systems using a voltage pump, the 18SCT005 has a built-in 1kHz low-pass filter eliminates noise from the effect of voltage pumping frequencies thus allowing accurate voltage measurements for portable systems using charge pumps. The very small footprint of the TSSOP8 (4.4mm) makes this IC ideal for compact application where saving space is important but its linearity and constant performance across temperature and voltage makes this the ideal choice for HV electronics in general.

The 18SCT005 can monitor AC/DC supply lines in high-voltage charging systems and in battery powered electric vehicles. Using an external mid-rail reference, the 18SCT005 can monitor $240Vac(+20\%)$ with V_{dd} of $2.70V$ because of its rail-to-rail output guaranteed to better than $10mV$ from power rails. For DC system the 18SCT005 responds in about $1mSec (<1\%)$ to pulse transitions allowing quick response to abrupt DC voltage change. This allows prompt response to catastrophic changes in high-voltage systems.

This flexible IC is available in a very small footprint TSSOP (4.4mm) package which meet spacing and creepage requirements up to $\pm 1430V$ (Ref UL 60950-1) for a simple pcb system implementation without slot or conformal coating. Also a Dual In Line version is available for easy prototyping. The 18SCT005 very efficiently replace bulky high voltage resistors.

Block Diagram

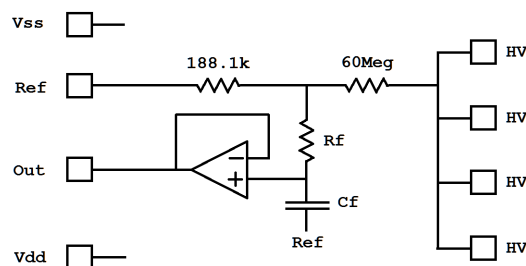

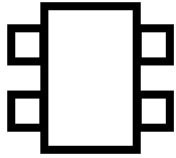

Absolute maximum rating

Input Voltage ($V_{HV} - V_{SS}$)	+/-1200 V
Low Voltage Power Supply ($V_{dd} - V_{ss}$)	5.5V
Reference Voltage	-0.6V to $V_{dd} + 0.5V$
Output Voltage	-0.6V to $V_{dd} + 0.5V$
Operating temperature	-40 C to 105 C
Storage temperature	-65 C to 150 C

Recommended operating conditions

PARAMETER	MIN	MAX	UNIT
High-Voltage ($V_{HV} - V_{SS}$)	-1200	1200	V
Low-Voltage Supply ($V_{dd} - V_{ss}$)	2.7	5.5	V
Capacitive Load	0	500	pF

Operating Voltage

The 18SCT005 is designed to operate from either 3V or 5V supplies and is available in the following versions allowing the following recommended minimum (Output to $V_{ss} + 10mV$) and maximum high-voltage (Output to $V_{dd} - 10mV$) input to be applied from -55C to 125C.

Version	Package	Gain(ppm)	HV _{min}	HV _{max}	Note
18SCT005AFW	TSSOP8	3125	-1200	+1200	Commercial
18SCT005ADL	DIL8	3125	-1200	+1200	Commercial
18SCT005AFWA	TSSOP8	3125	-1200	+1200	Automotive Grade (in qualification)

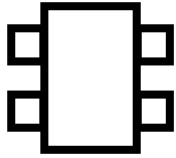

Electrical characteristics (Temp = -40C to +125C; Vcc=5V)

For 18SCT005FW (Divider Ratio = 3125ppm)

	PARAMETER	TEST CONDITIONS	MIN	TYP	MAX	UNIT	Referring Charts
ΔV_{out0}	Low Output Voltage	$V_{HV}=0V; V_{ref}=0V; R_{load}=1Meg$ to Vdd	0	1.0	10	mV	Chart 12, 13
ΔV_{out5}	High Output Voltage from Vdd	$V_{HV}=5V; V_{ref}=5V; R_{load}=1Meg$ to Vss	-15	2.0	0.0	mV	Chart 12, 13
V_{osP}	V(out) offset to V(ref) at 0.25V	$V_{out}(V_{HV}=0.25V)-V_{ref}; V_{ref}=0.25V$	-6.0	0.0	6.0	mV	Chart 11
V_{os}	V(out) offset to V(ref) at 2.5V	$V_{out}(V_{HV}=2.5V)-V_{ref}; V_{ref}=2.5V$	-2.0	0.0	2.0	mV	
V_{osN}	V(out) offset to V(ref) at 4.75V	$V_{out}(V_{HV}=4.75V)-V_{ref}; V_{ref}=4.75V$	-3.0	0.0	3.0	mV	
I_{dd0V}	Supply Current at $V_{out} = 0V$	$V_{HV}=0V; V_{ref}=0V; R_{load}=1Meg$ to Vss	0.01	0.4	5.0	mA	Chart 21
$I_{dd2.5V}$	Supply Current at $V_{out} = 2.5V$	$V_{HV}=2.5V; V_{ref}=2.5V; R_{load}=1Meg$ to Vss	15	50	250	μA	Chart 21
V_{800V}	V(out) at 800V	$V_{out}(800V); V_{ref}=0V; Temp=25C$	2.4816	2.500	2.5166	V	
A_V	Divider Ratio at 800V	$V_{out}(800V)/800; V_{ref}=0V$	3102	3125	3146	ppm	Charts 14, 15, 16, 17
R_{HV}	Input Resistance	$V_{HV}(100V)/I(V_{HV}); V_{ref}=0V$	20.0	60.0	120.0	Meg Ω	Chart 10, 11, 12
T_{C1}	Resistance 1st Order Temp.Co.	Temp -40C to 125C		-4400		ppm/C	Chart 10, 11, 12
T_{C2}	Resistance 2nd Order Temp.Co.	Temp -40C to 125C		+12.2		ppm/C	Chart 10, 11, 12
T_{r90}	Rise Time to 90%	$V_{HV}=10V$ to 200V ($T_r=100\mu S$); $V_{ref}=0V$ T_{r90} = Time from 50% to 90%* $V_{out}(200V)$		0.45		μSec	
T_{f10}	Fall Time to 10%	$V_{HV}=200V$ to 10V ($T_f=100\mu S$); $V_{ref}=0V$ T_{f10} = Time from 50% to 10%* $V_{out}(200V)$		0.52		μSec	
$T_{R/F}$	Rise/Fall Time to 1%	$V_{HV}=10V$ to 200V; $V_{HV}=200V$ to 0V; $V_{ref}=0V$		1.2		mSec	Charts 7, 8, 9
F_C	HV Cut-off Frequency	$V_{HV}=240Vac; V_{ref}=2.5V$		950		Hz	Charts 1, 2
ΔA_{V60}	Gain Difference at 60Hz	$V_{HV}=240Vac; V_{ref}=2.5V$		+0.1		%	Charts 3, 4, 5, 6
$PSRR_{60}$	Power Supply Rejection Ratio	Vdd+Vddac(100mVrms) at 60Hz		-50		dB	Charts 18, 19
ΔA_{VT}	Gain Temperature Stability	Max(A_V)-Min(A_V) between -40 to 85C		1.5		ppm	Chart 20

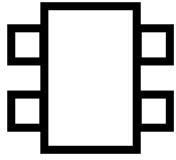

Application Notes:

The 18SCT005 is designed to accurately convert very high-voltages into a lower voltages readily compatible with regular low voltage electronics. All systems using a high-voltage need to know that voltage at some point in time. The 18SCT005 makes this task easy. Although initially designed for DC voltages the 18SCT005 will also handle AC voltages provided the frequency is not to high. Usual power line frequencies of 50 to 60Hz are within the range of frequencies which the 18SCT005 can handle very well.

The built-in output voltage buffer allows true rail-rail output operation. The chip can have the reference voltage input connected to Vss or any other voltage capable of sinking the maximum current coming from the HV input resistors (max 120uA). Connecting the reference input to Vss is most commonly used for DC applications and brings the output range to a minimum of 0V and to a maximum of HV_{max}.

a) DC Applications:

The output voltage of the 18SCT005 is dictated by the equation below assuming all voltages are referred to Vss:

$$V_{Out} = V_{Ref} + V_{os} + A_V * (V_{HV} - V_{Ref}) \quad \text{eq. 1}$$

Thus

$$V_{HV} = V_{Ref} + (V_{Out} - V_{Ref} - V_{os}) / A_V \quad \text{eq. 2}$$

The schematics below shows a typical DC application with optional output resistor Rout simulating an actual load.

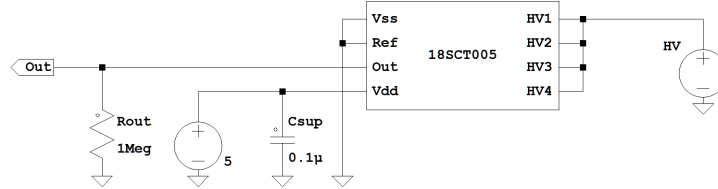

Figure 1: Typical DC application schematic.

In most DC application the user will want to measure a high-voltage with respect to Vss and will consider V_{os} to be negligible compared to V_{Ref}. In this case eq. 2 simplifies to:

$$V_{HV} = V_{Ref} + (V_{Out} - V_{Ref}) / A_V \quad \text{eq. 3.1}$$

$$V_{HV} = V_{Ref} + (V_{Out} - V_{Ref}) * 320 \quad \text{eq. 3.2}$$

b) AC Applications:

For most AC voltage measurement, the 18SCT005's HV input will vary by a certain sinusoidal voltage around 0V. This is certainly true when capacitive coupling HV to the IC is used. When measuring AC voltages, the reference input should be connected to an external voltage source to allow the output voltage to show the negative high-voltage excursion. Usually a voltage close to mid-rail (V_{dd}/2) is appropriate but any voltage which allows this negative excursion will suffice. When a non-zero value for the Reference voltage is used, the output voltage corresponding to V_{HV} = 0V becomes:

$$V_{Out0AC} = V_{Ref} + V_{os} + A_V * (0 - V_{Ref}) \quad \text{eq. 4}$$

or

$$V_{Out0AC} = V_{Ref} * (1 - A_V) = V_{Ref} * 319 / 320 \quad \text{eq. 5.1}$$

$$V_{Out0AC} = V_{Ref} * 0.996875 \quad \text{eq. 5.2}$$

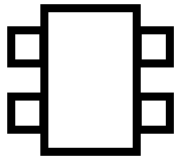

This value is very close to V_{Ref} but is not exactly V_{Ref} . Observe that in this case the actual value of V_{os} may be important for the application.

The schematics below shows a typical AC application with optional output resistor R_{out} simulating an actual load.

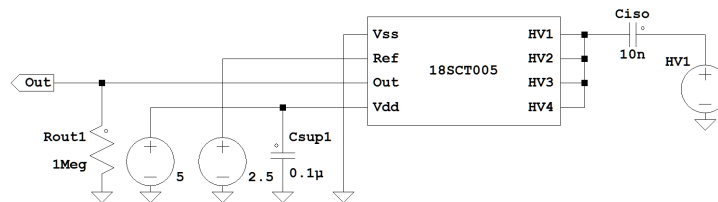
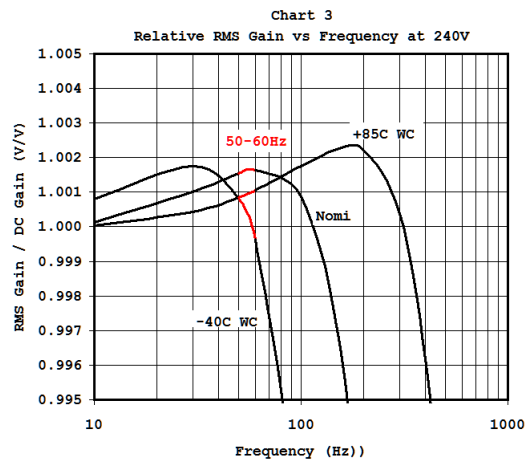
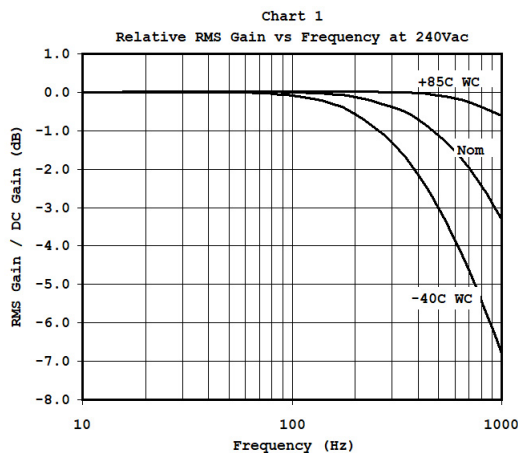

Figure 2: Typical AC application schematic.

Mid-raid V_{os} is about 0.6mV maximum for the 18SCT005 and makes neglecting its value appropriate in most AC applications. At V_{dd} of 5V and V_{Ref} of 2.5V the difference between V_{Ref} and V_{Out0AC} is about 7.8mV. When referenced back to V_{HV} this difference is of course equal to V_{Ref} .

The discussion on AC application naturally brings forward a look into the 18SCT005 performance as a function of frequency. As mentioned earlier the IC was originally designed for DC application but it still has some very good AC and transient performances. In particular the performance as a function of frequency is quite stable. Charts 1 and 3 are reproduced below to ease the discussion.



The reader will note how flat the frequency response is in the usual frequencies of interest of 50 to 60Hz where the AC gain is only about 0.1% higher than the DC gain with little variation with temperature (-40 to 85C) and with IC specifications. The user can therefore in confidence measure AC voltages in the frequency range of 50 to 60Hz quite reliably. Observe that “WC” in the charts above means “Worse Case”.

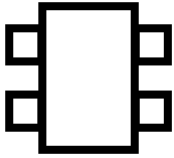

The internal circuitry used in the 18SCT005 does introduce some level of distortion in AC signals. As the AC voltage is brought down to lower values this distortion starts to impact the RMS value of the voltage read. Chart 6 reproduced below shows the impact of this distortion on the AC RMS value of the voltage read at the output.

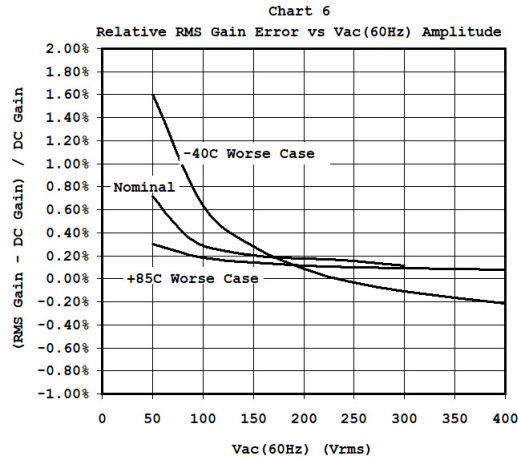

The error induced is small, typically about 1% at 50Vrms. It is also worth noting that the relative error decreases as the AC voltage increases.

c) Pulse/Transient Applications:

For pulse measurements application the 18SCT005 performs well at transition times of about 1-1000uSec. Even on a hard up or down transition with T_{rise} or T_{fall} of about 0.5uSec (See charts 7, 8 below and 9 later) the transitions on V_{out} are mostly determined by the internal RC filter ($\tau \sim 170uSec$). Some Overshoot and undershoot is visible but it sits at just about 1% of the signal amplitude change. Negative undershoot is of course only visible when V_{Ref} is set to a value higher than 0V.

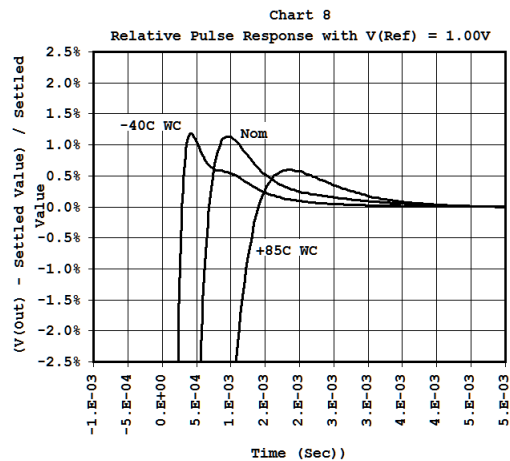
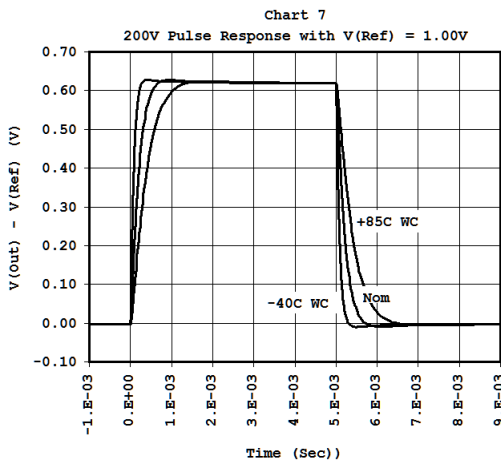

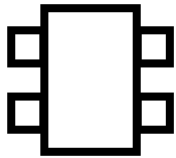

d) HV Input Resistance:

What differentiates the 18SCT005 from discrete solutions is that the exact same material is used for the high and low resistances on an IC which operates at essentially a constant and uniform temperature. The ratiometric measurement which results from this combination is inherently stable in temperature and very much so in voltage as well. Like in every engineering solution there are compromises to be made and the 18SCT005 is no exception.

First the material used to construct the divider resistance exhibits a strong temperature dependence (Chart 10 below) and it is inherently difficult to accurately control its as-manufacture sheet resistance as a result the specified resistance of the high-voltage sensing resistor network varies substantially. Matching is however very good and although some trimming is used (see Chart 20) in this product the performance without trimming would still be excellent (<1%).

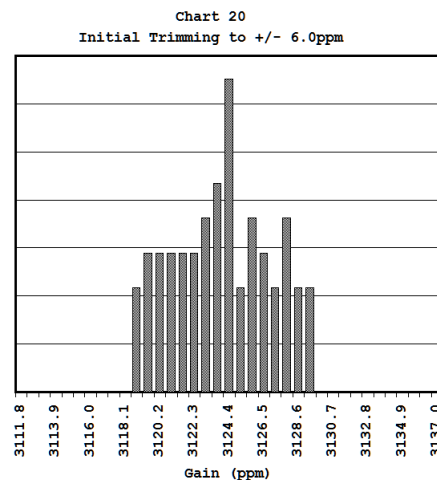
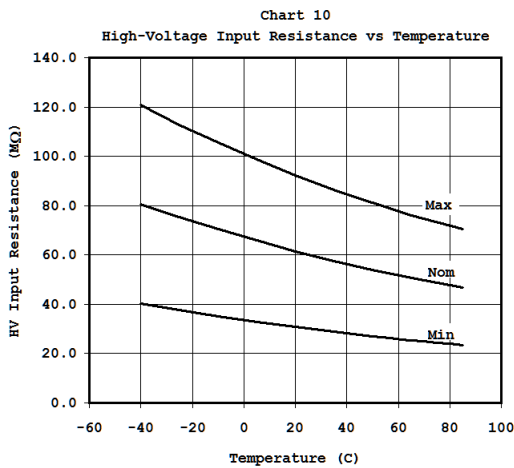

This being said the resistor network performance in temperature and voltage is very good. Charts 15 and 16 below gives a good overview of the resulting DC conservative accuracies.

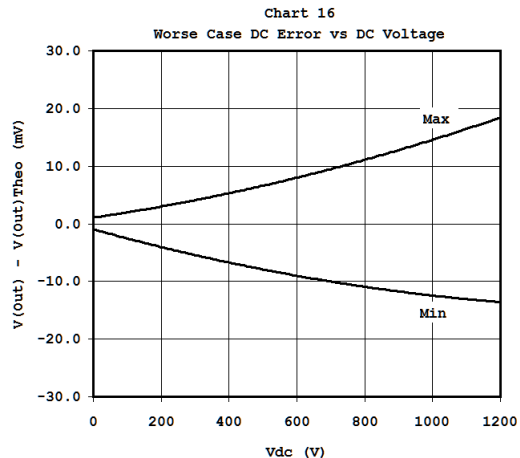
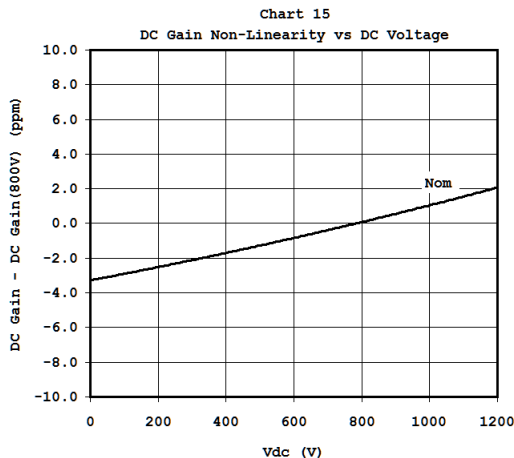

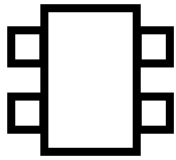

e) Power Supply Rejection Ratio:

The engineering compromise used to obtain good performance at high voltage with the 18SCT005 come with a small price to pay, the PSRR performance is modest. Chart 18 and 19 shows the PSRR for circuit in figure 1 and circuit in figure 3 respectively. Chart 19 is the PSRR performance with the circuit in figure 3.

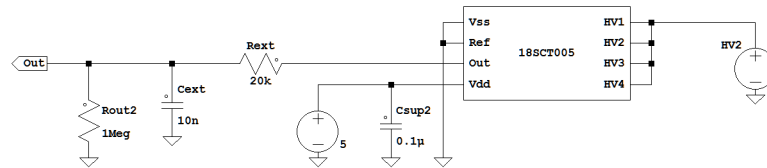
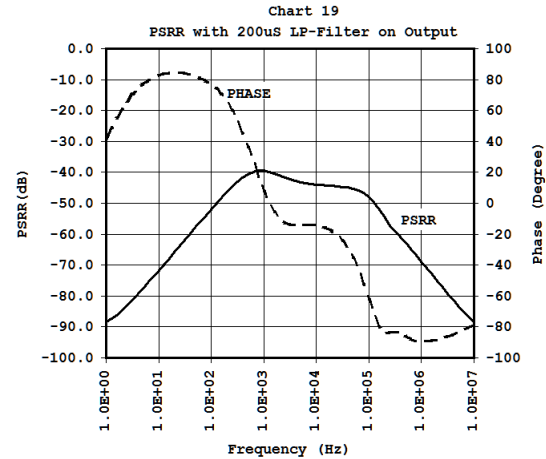
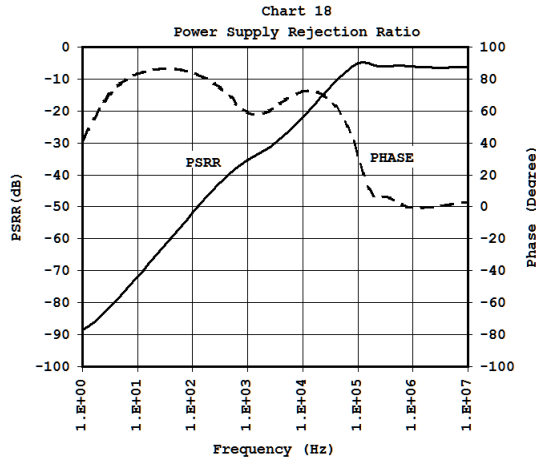
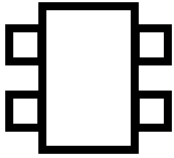

Figure 3: Typical DC application schematic with simple low-pass filter on output to improve PSRR performance.

f) Driving Capacitive Loads:

The 18SCT005 can directly drive capacitive loads up to about 1nF but driving more capacitive loads may cause the output to oscillate. One simple way to resolve this is to use an output snubber as depicted in Figure 3 above to prevent the problem. When doing this make sure to keep in mind that the system gain will be somewhat lower than 3125ppm as the output resistor network will act as a voltage divider.

One other consequence of using this circuit on the output is that the transient response will be slower. This may help reduce/eliminate the small overshoot on the output signal during a sharp transition but the output voltage slope will be reduced.



g) Power Supply Current:

The Current drawn from the main circuit is quite small, about 35uA (Chart 21). It varies little with temperature, Vdd and output voltage. Except at $V_{Out} \sim 0V$ where it increases substantially to about 500uA. There are cases where Idd may increase up to a few mA at $V_{Out} = 0V$ but it still remains in comfortable range for most modern circuits.

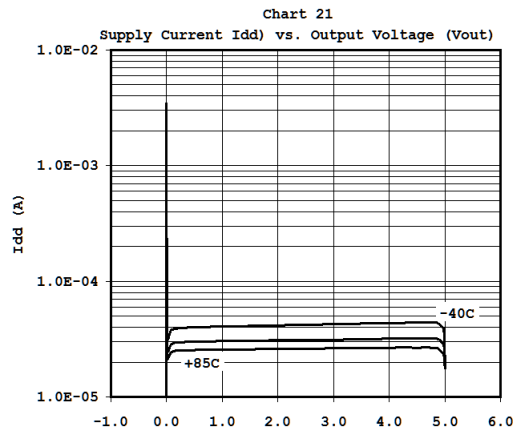

f) High-Temperature Drift:

As can be seen on Chart 22 (reproduced below) the 18SCT005 is very stable when subjected to high temperature (125C) and bias (800V). Dynamic measurement of the output voltage shows a drift of only about +0.05% (+1.5ppm) after 250hrs with most of the drift happening during the first 100hrs.

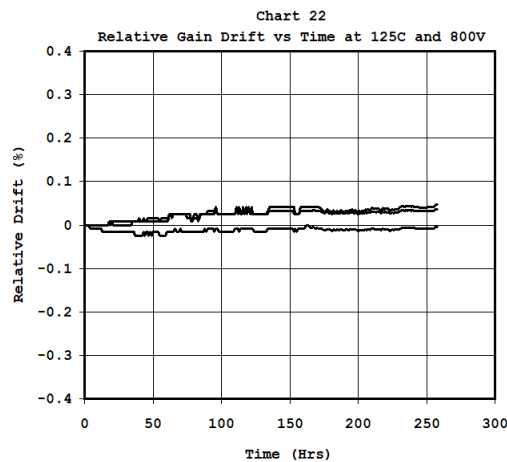

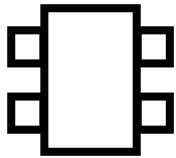

TYPICAL CHARACTERISTICS

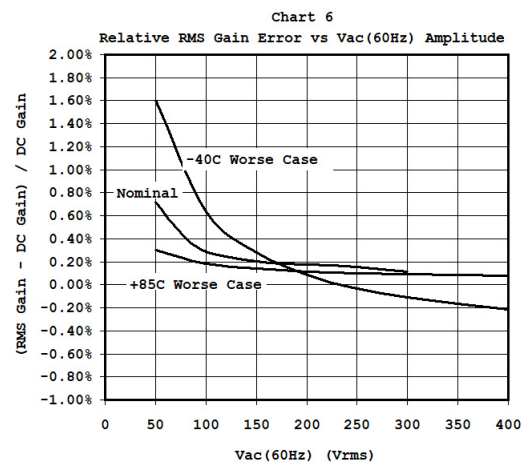
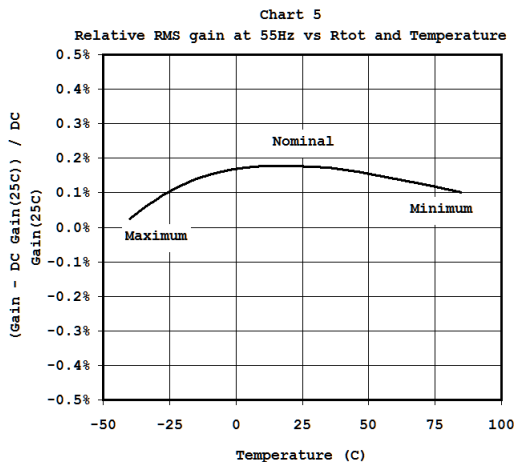
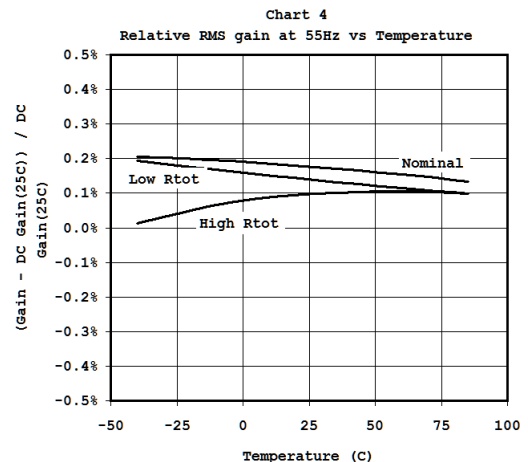
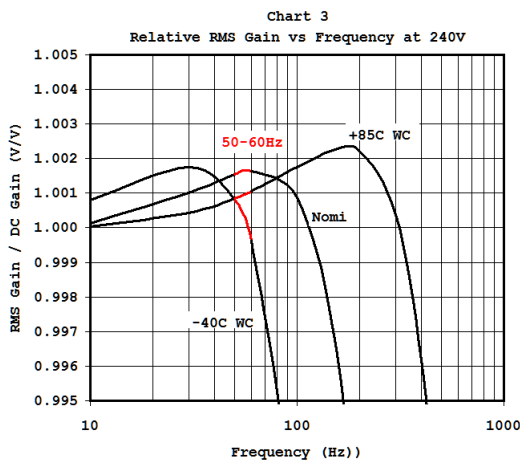
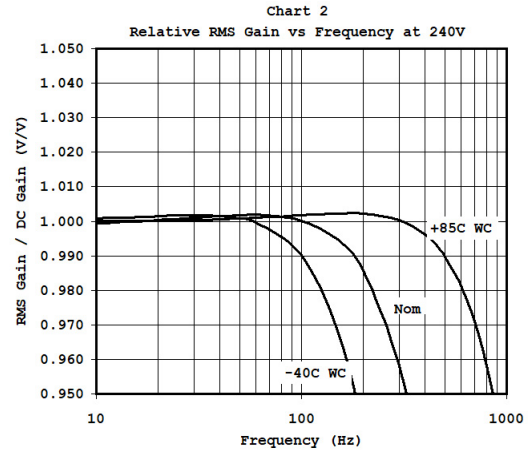
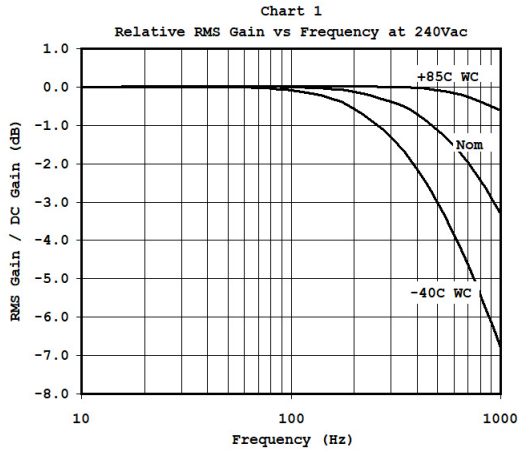

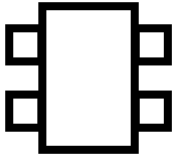

TYPICAL CHARACTERISTICS (Cont.)

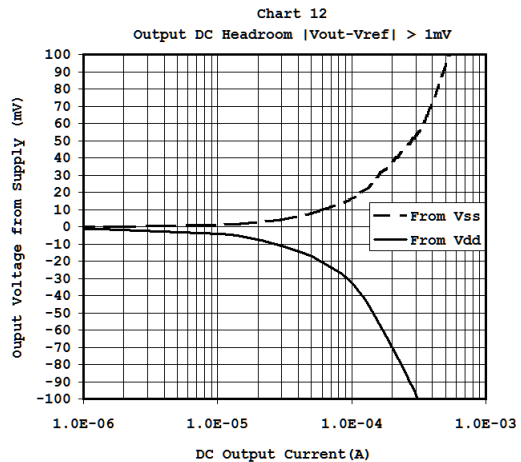
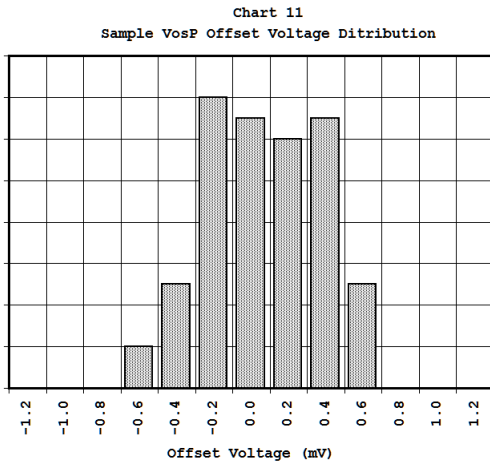
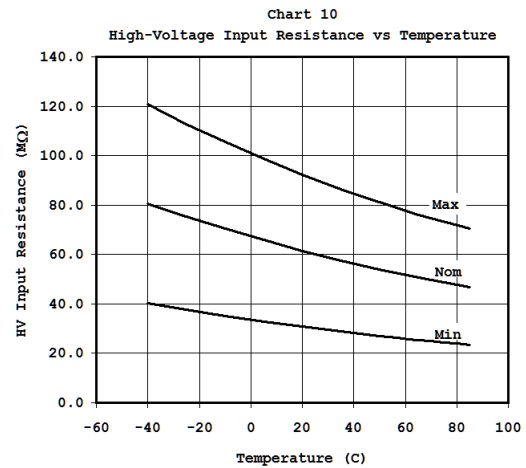
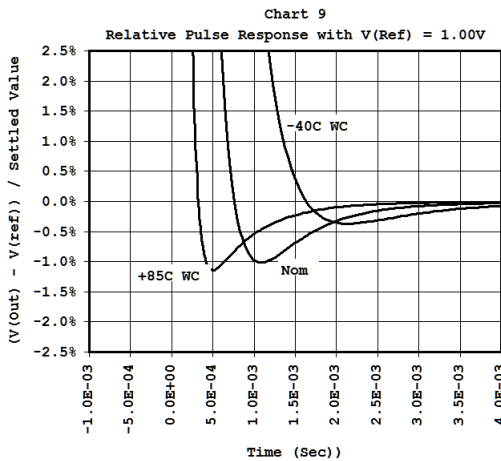
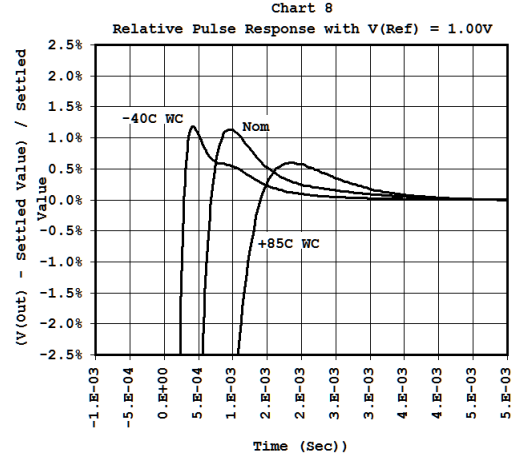
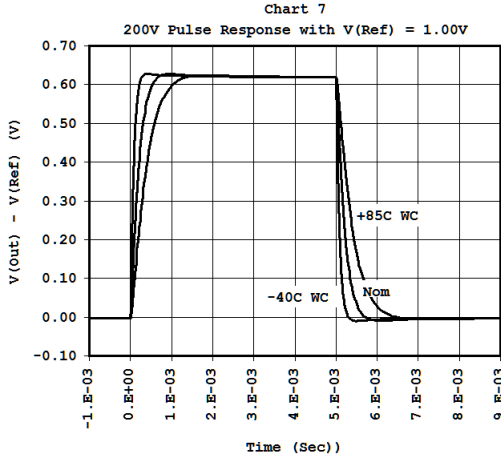

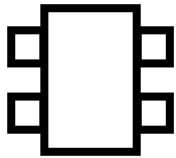

TYPICAL CHARACTERISTICS (Cont)

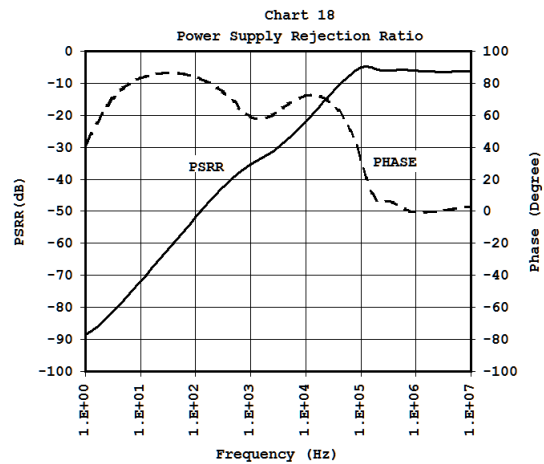
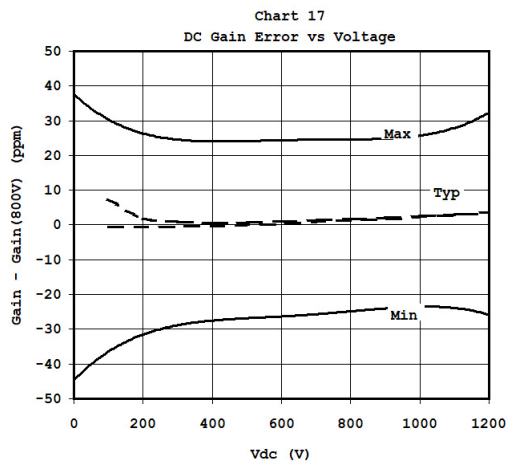
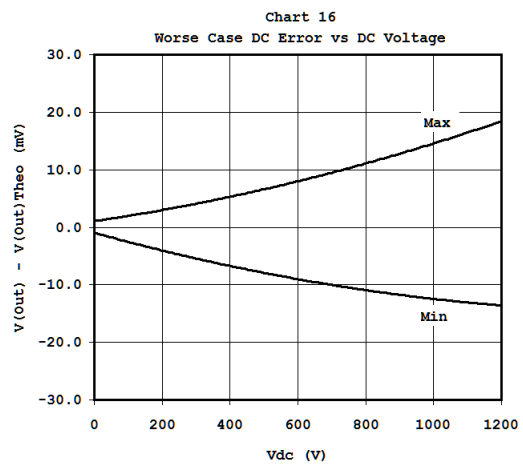
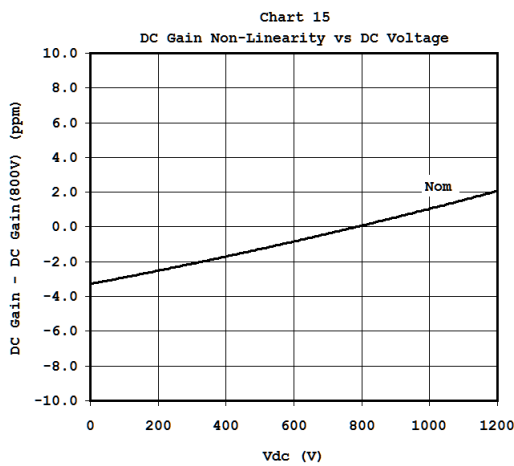
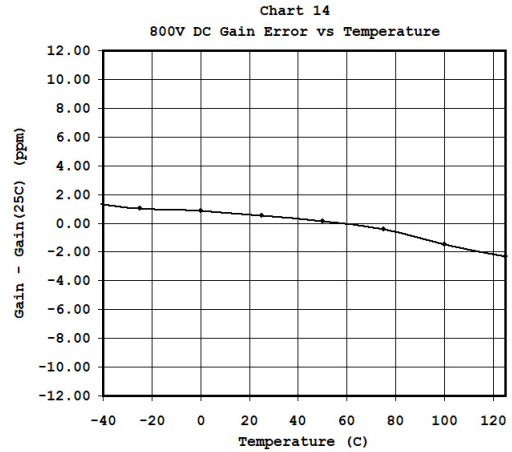
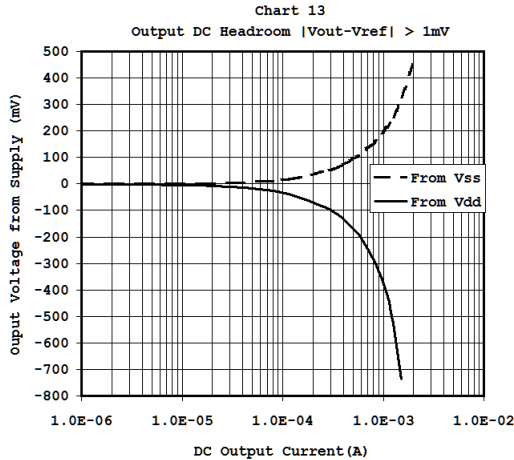

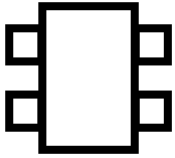

TYPICAL CHARACTERISTICS (Cont)

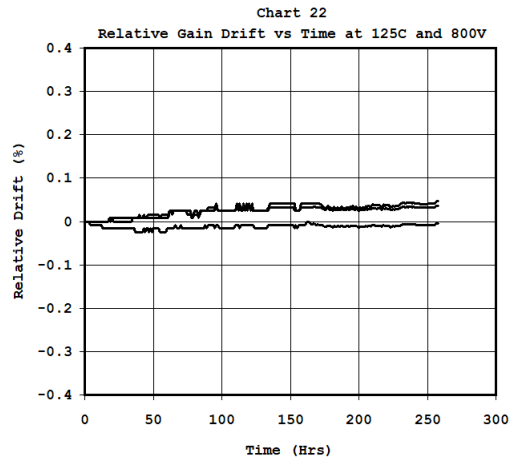
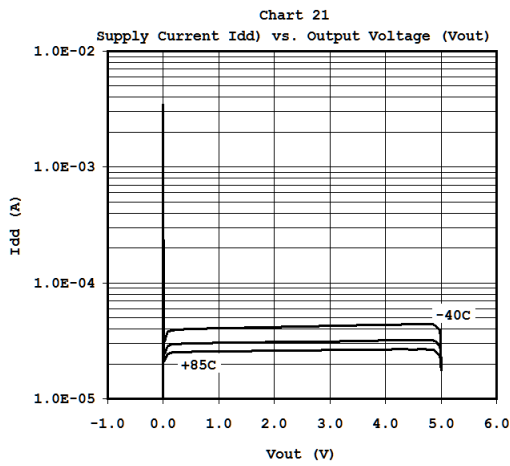
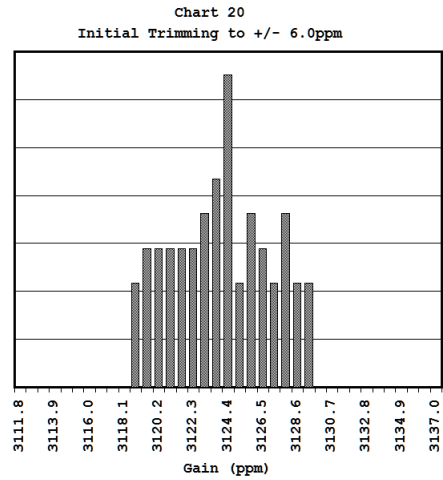
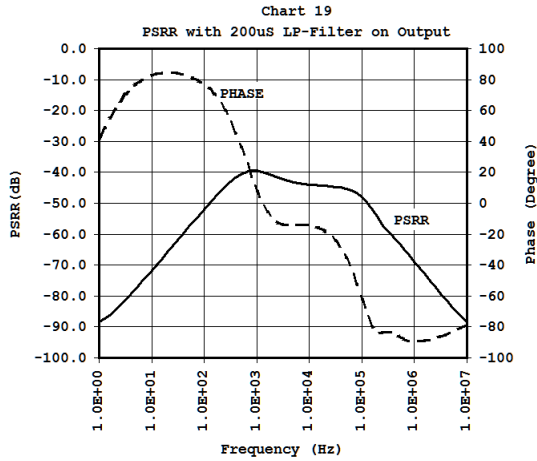

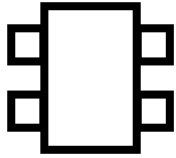

SPICE PARAMETERS

Not Available yet

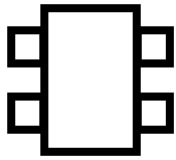

DIMENSIONS

TSSOP-8 Wide-Body (4.4mm)

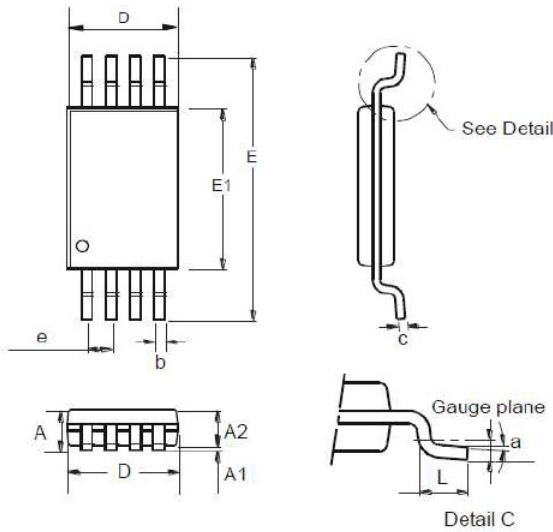

ALL Dimensions in mm			
Dim	Min	Max	Typ
a	0.09	-	-
A	-	1.20	-
A1	0.05	0.15	0.925
A2	0.825	1.025	-
b	0.19	0.30	-
c	0.09	0.20	-
D	2.90	3.10	3.025
e	-	-	0.65
E	-	-	6.40
E1	4.3	4.50	4.425
L	0.45	0.75	0.6

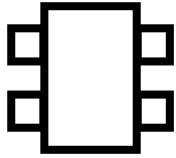

Product Ordering Information:

PART NO.18SCT005RXX-MM

Device:	18SCT005
Divider Ratio (R)	A = 3125ppm
Package (XX):	FW = TSSOP-8 Wide Body
Media Type (MM):	TU = Tube TR = Tape & Reel (in qualification)

Product Marking:

18005R
Ennnnn
##@@

Where:

“R” is Divider Ratio as defined above.

“nnnnn” is a proprietary identifying number.

“##” is the year

“@@” is the week number